

LC503AHR2-30P-A

Features

5mm Package
 High Optical Power
 High Luminous Intensity
 Slightly Diffused Lens
 All Plastic Mold Type
 LEAD FREE

Applications

Outdoor Message Centers
 VMS
 Automotive Interior Lighting
 Traffic Signals
 Pedestrian Signals
 Decorative Lighting



ATTENTION

OBSERVE PRECAUTIONS
 ELECTROSTATIC
 SENSITIVE DEVICES

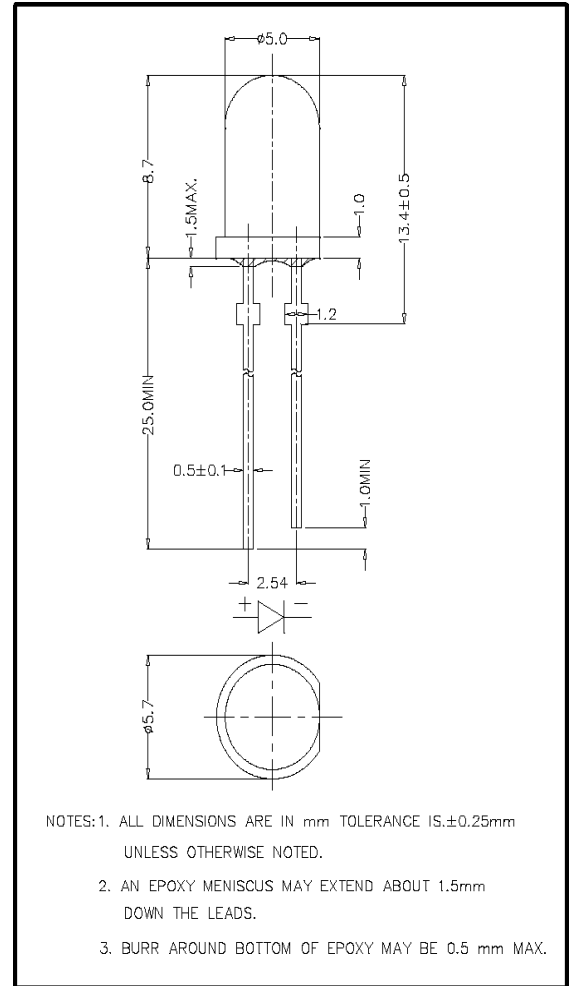

Maximum Ratings (Ta=25°C)

Characteristic	Symbol	Max.	Unit
Forward Current	I _F	50	mA
Reverse Voltage	V _R	5	V
Power Dissipation	P _D	130.00	mW
Operating Temperature	T _{opr}	-40 ~ +95	°C
Storage Temperature	T _{stg}	-40 ~ +100	°C
Soldering Temperature	T _{sol}	260	°C
Soldering Time	-	for 3 sec. max	-

Opto-Electrical Characteristics (Ta=25°C)

Characteristic	Symbol	Test Condition	Min	Typ	Max	Unit
Forward Voltage	V _F	I _F =20mA	-	2.10	2.60	V
Reverse Current	I _R	V _R =5V	-	-	100	μA
Luminous Intensity	I _v	I _F =20mA	2130.00	3500.00	-	mcd
Viewing Angle	2θ ^{1/2}	-	-	30°	-	deg.
Peak Wavelength	λ _p	I _F =20mA	-	632	-	nm
Dominant Wavelength	λ _d	I _F =20mA	-	624	-	nm
Spectral Line Half Width	Δλ	I _F =20mA	-	20	-	nm

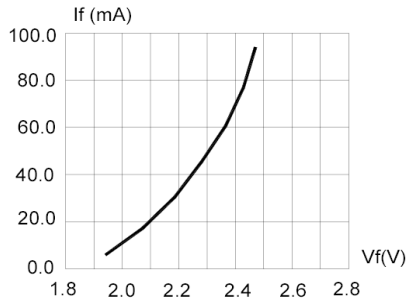

FIG.1 FORWARD CURRENT VS. FORWARD VOLTAGE.

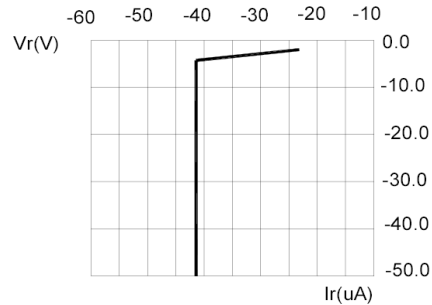

FIG.2 REVERSE CURRENT VS. REVERSE VOLTAGE.

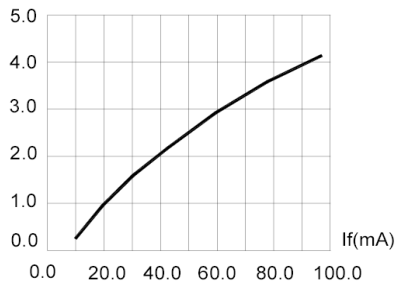

FIG.3 RELATIVE LUMINOUS INTENSITY VS. FORWARD CURRENT.

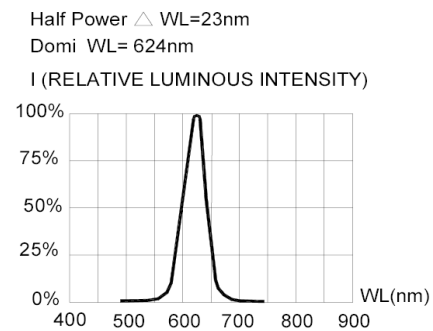

FIG.4 RELATIVE LUMINOUS INTENSITY VS. WAVELENGTH.

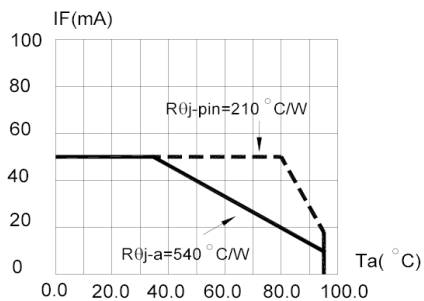

FIG.5 MAXIMUM FORWARD DC CURRENT VS. AMBIENT TEMPERATURE (Tjmax=105 °C)

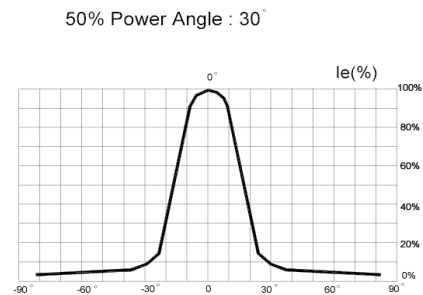

FIG.6 FAR FIELD PATTERN

1. Cathode PAD Area (0.18 X 0.18inch²)
2. Height above nominal seating plane in inches(0.3inch)